

PACE[®]

TR-48 *analog computer*

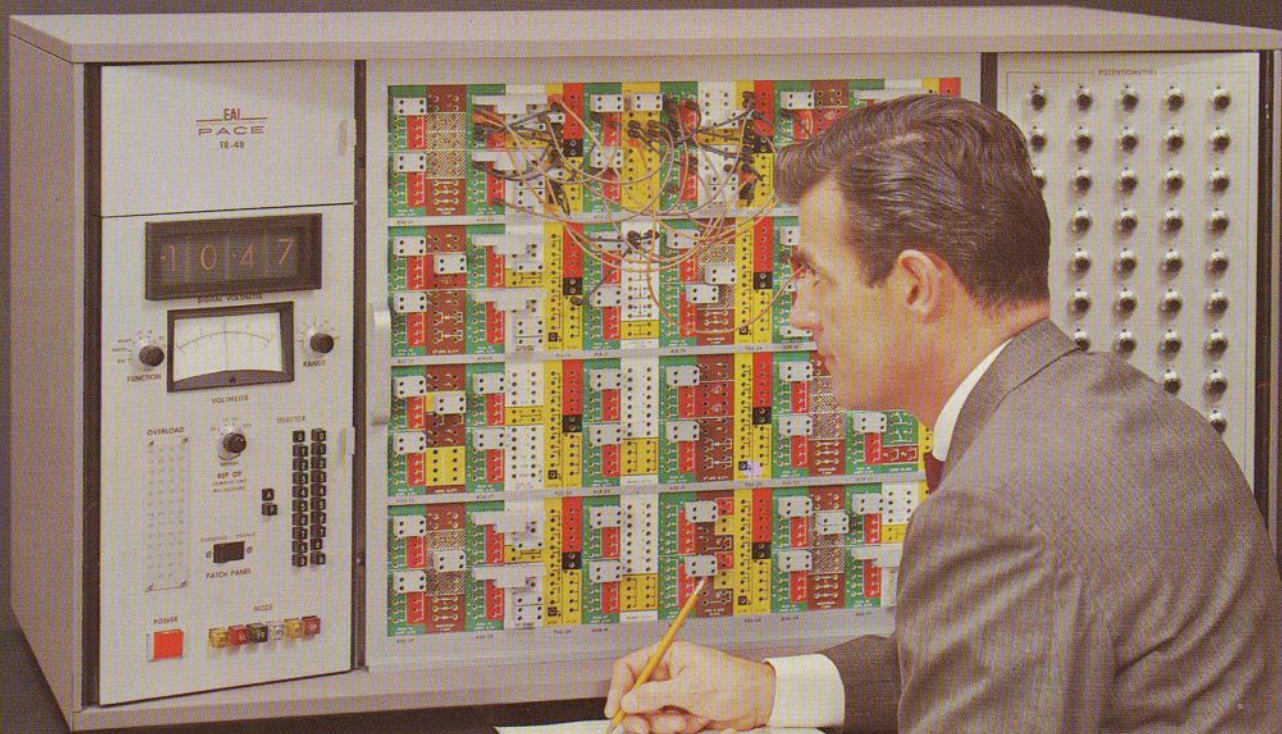

EAI Electronic Associates
GmbH, Aachen
MARTINSTR. 14

EAI

ELECTRONIC ASSOCIATES, INC. *Continental Branch - Brussels, Belgium*

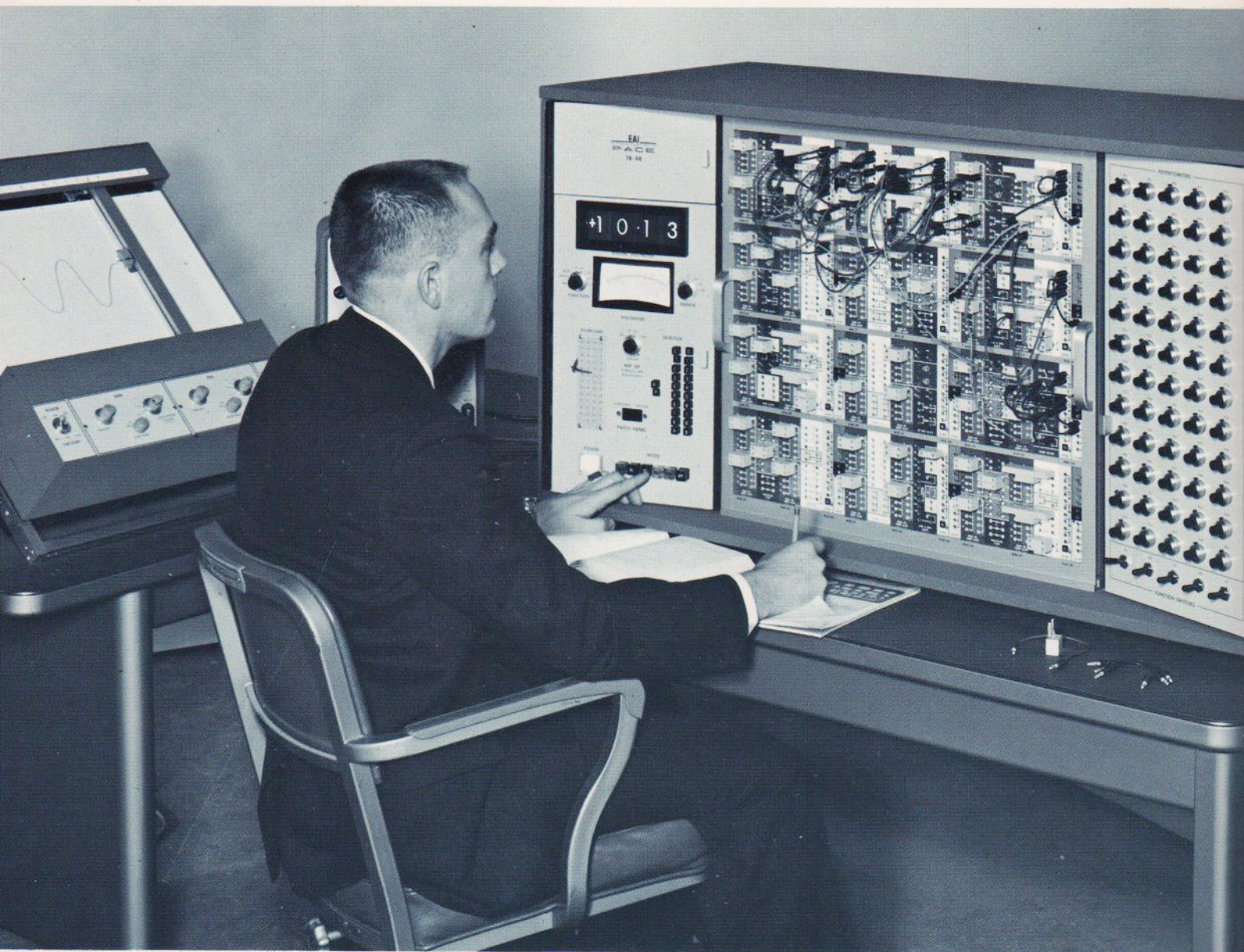

5 *steps to the solution of your
routine engineering problems . . .*

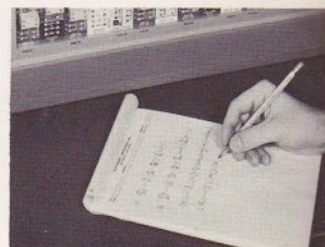

Step 1—Problem Analysis
*Problem is translated into
mathematical description using
algebraic and differential
equations.*

This new EAI computer makes the benefits of analog simulation available to all industrial, government or university research and engineering groups. Performing those mathematical operations required in the solution of most engineering problems the TR-48 expands your engineering effort by offering . . .

Universal approach to scientific design . . . the behavior of systems belonging to many and varied areas of physics and chemistry are governed by the same physical principles.

Simplified mathematical approach . . . circumvents the shortcomings and excessive educational requirements of a purely mathematical approach.

Better physical insight into operation of the physical system rather than purely mathematical description.

Concentrated effort on design optimization . . . gives the engineer a "feeling" for his problem without the distraction of conventional calculations.

A computational tool compatible with problem synthesis . . . the engineer can easily change problem parameters and immediately observe the resulting changes in the system response.

Easy communication between problem and computer . . . variables of the system under study are represented by easily understood analogous physical quantities.

Direct Graphical Representation of problem solution.

PACE TR-48

analog computer combines experience proven design with increased problem solving capabilities

The compact, solid-state design of the TR-48 provides an analog computer large enough to solve problems typical of most engineering groups, and which can be located right in the laboratory. No elaborate installation facility with a specially trained technical staff to operate it is required . . . no air-conditioned room . . . no special power requirements—it can be powered from any ordinary electrical outlet . . . and because of its design simplicity and field proven dependability no maintenance staff is required.

The TR-48 makes it convenient for the engineer with the problem to use the computer . . . the individual most familiar with the problem is present during the course of the simulation to make those design decisions that only he can make . . . thus maximum benefits from analog simulation are obtained. The engineer can experiment with new designs that formerly were too costly or time consuming to try. He can perfect the design and work out all the "bugs" right on the computer . . . before building pilots or prototypes, drastically reducing design time and costs.

This dependable new computational tool is completely solid-state for highest reliability and long trouble-free life. Its design carries with it the history of maintenance-free reliability of its famous companion, the PACE TR-10, the first completely transistorized analog computer.

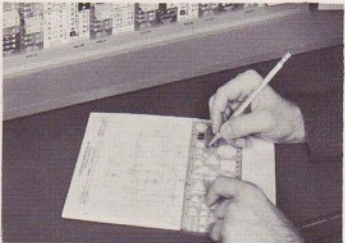

Step 2—Programming

An information flow sheet is prepared using a block diagram to represent the various computer elements and their interconnections.

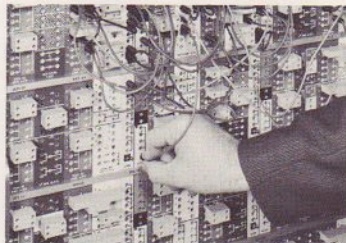

Step 3—Patching

With the aid of this diagram patch cord and bottle plug connections are made between various computer components.

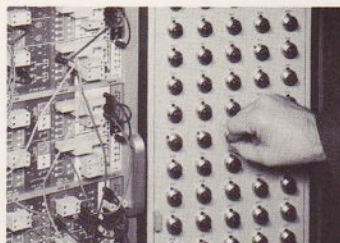

Step 4—Insertion of Problem Parameters

Coefficient setting potentiometers are adjusted to provide design parameter inputs.

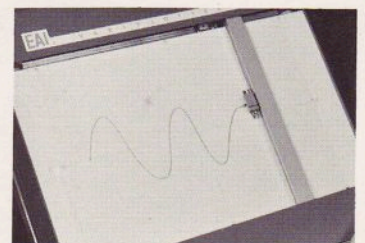

Step 5—Solution

The computer solution is performed in the exact manner prescribed by the mathematical equations. Solutions are presented on an XY plotter.

TR-48

is quality engineered for simplicity, flexibility and maintenance-free operation

Proven solid-state design . . . instant warm-up—no cooling problems. Completely solid-state design based on the field proven circuits of its famous predecessor, the PACE TR-10, of which over 300 units have compiled a remarkable history of trouble free operation.

High Speed Repetitive Operation . . . substantially reduces the time required in arriving at the "optimum" problem solution.

Removable patch panel . . . problem circuits can be patched and checked off the computer—thus making most efficient use of actual time. Patched boards can be stored for future use.

Modular patch panel layout . . . patch panel is divided into 12 similar functional areas, each terminating operational amplifiers, integrator networks, potentiometers, multipliers, and function generators. This unique layout vastly reduces "patch panel clutter" and thus aids in minimizing programming errors and consequent "debugging" time. Color coded component terminations promote programming efficiency. The layout is easily changed to accommodate changes in component configuration.

Bottle Plugs . . . cut down on costly programming time and patch cord clutter, significantly simplifying the programming operation.

Plug-in components . . . may be replaced easily and quickly for expansion or servicing.

Non-linear components . . . interchangeably plug into non-linear positions and most integrator network positions within the modules. Number of computer configurations are limited only by the number of components kept on hand.

Basic computer . . . is pre-wired to accept the maximum complement of components—can be expanded

simply by plugging in desired components—no additional wiring necessary.

Draws less power than 150 watt bulb . . . no special power requirements—operates from any 115 volt, 60 cycle outlet. (Also 220 V/50 cps, 115 V/50 cps, 127 V/50 cps)

Built-in input resistors . . . each operational amplifier is terminated with convenient precision resistor networks; one-100K feedback resistor, two unity gain inputs, and two gain 10 inputs. Summing junction terminations permit the use of additional input elements.

10:1 Time scale . . . additional feedback capacitors in each integrator network permit the individual 10:1 selection of integrator time scale by bottle-plug.

Human engineered control panel . . . designed to aid problem solutions. All controls required for the complete operation of the computer are provided in one convenient location.

Electronic Digital Voltmeter . . . provides 4-digit reading—plus polarity—for the precise, rapid digital readout of problem voltages and for the setting of coefficient potentiometers.

Push-button readout . . . allows the output voltage of all amplifiers, coefficient potentiometers, and input trunks to be monitored on the Digital Voltmeter or multi-range voltmeter.

Push-button mode control . . . provides a convenient means for controlling the operating modes of the computer.

Bus bar power distribution . . . utilization of gold-plated, Taper-Tab, copper bus bars eliminates complex rear power cabling and simplifies maintenance.

removing multicolored pre-patch panel

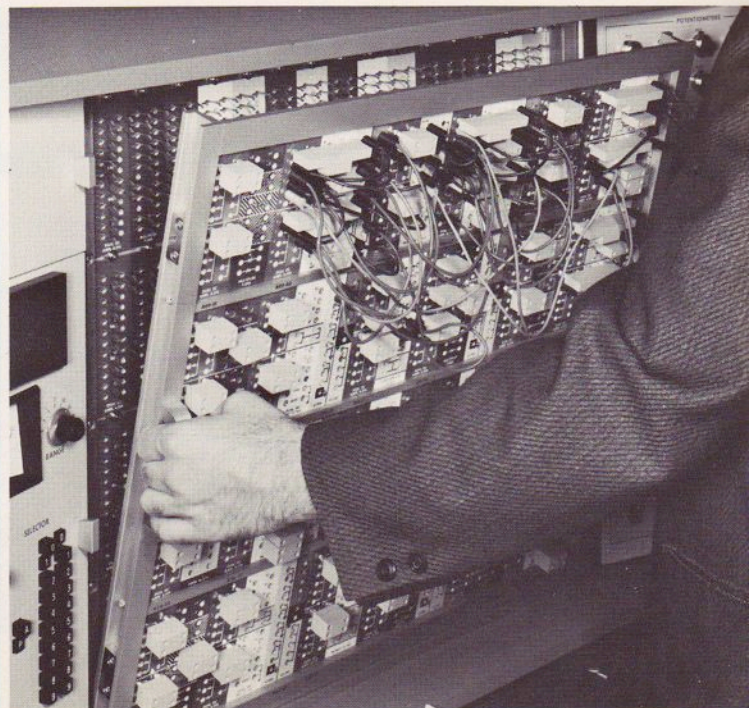

TR-48

control panel is engineered to aid problem solutions

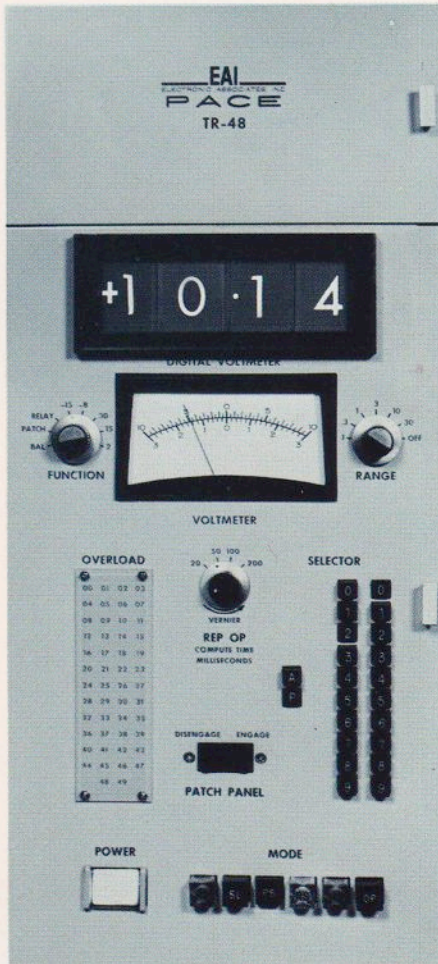

Control Panel is the nerve center of the TR-48 Computer . . . placing all controls for the complete operation of the computer in one convenient location. Human engineered panel design facilitates computer utilization and problem solution . . . provides means for controlling computer operation and metering of component output voltages. All knobs, push-buttons, and switches are clearly labeled for easy identification.

Mode Control . . . computer operating modes . . . POT SET, RESET, HOLD, OPERATE AND REPETITIVE OPERATION . . . are selected by means of push-button . . . each illuminated when energized, allowing the engineer to determine at a glance the computer operating condition.

Output Selector . . . push-button switches allow the output voltage of all amplifiers, coefficient potentiometers, and input trunks to be monitored on the Digital Voltmeter or multi-range voltmeter. The Output Selector is also terminated on the patch board permitting outputs of interest to be monitored on external equipment.

Voltmeter . . . a precision, multi-range meter for the monitoring of amplifier outputs, input trunks and power supply voltages, and also used for the manual balancing of operational amplifiers. Five meter ranges are selected by rotary switch.

VM Selector Switch . . . selects power voltages or outputs selected by push-buttons for reading on voltmeter.

HSRO Control . . . permits the selection and adjustment of solution time for those TR-48's equipped with High Speed Repetitive Operation.

Overload Indicator Panel . . . immediately identifies any amplifier that is in an overload condition.

Power Switch . . . allows control of primary power to computer by push-button.

electronic digital voltmeter

A digital voltmeter is provided on the TR-48 Control Panel for precise, rapid digital readout of computing voltages. Completely transistorized . . . there are no stepping switches . . . it offers the maximum in reliability. Its instantaneous operation vastly reduces time for coefficient problem checking and general readout of problem variables.

4-Digit Display . . . provides for automatic readings and polarity from 10 millivolts to ± 11.99 volts DC with fixed decimal point.

0.05% Accuracy . . . readings are accurate to ± 0.005 volts over the entire reading range.

Brilliant Output Display . . . a high-brilliance optical projection system is used to display the reading, sign, and fixed decimal point.

TR-48

modular patch panel simplifies programming

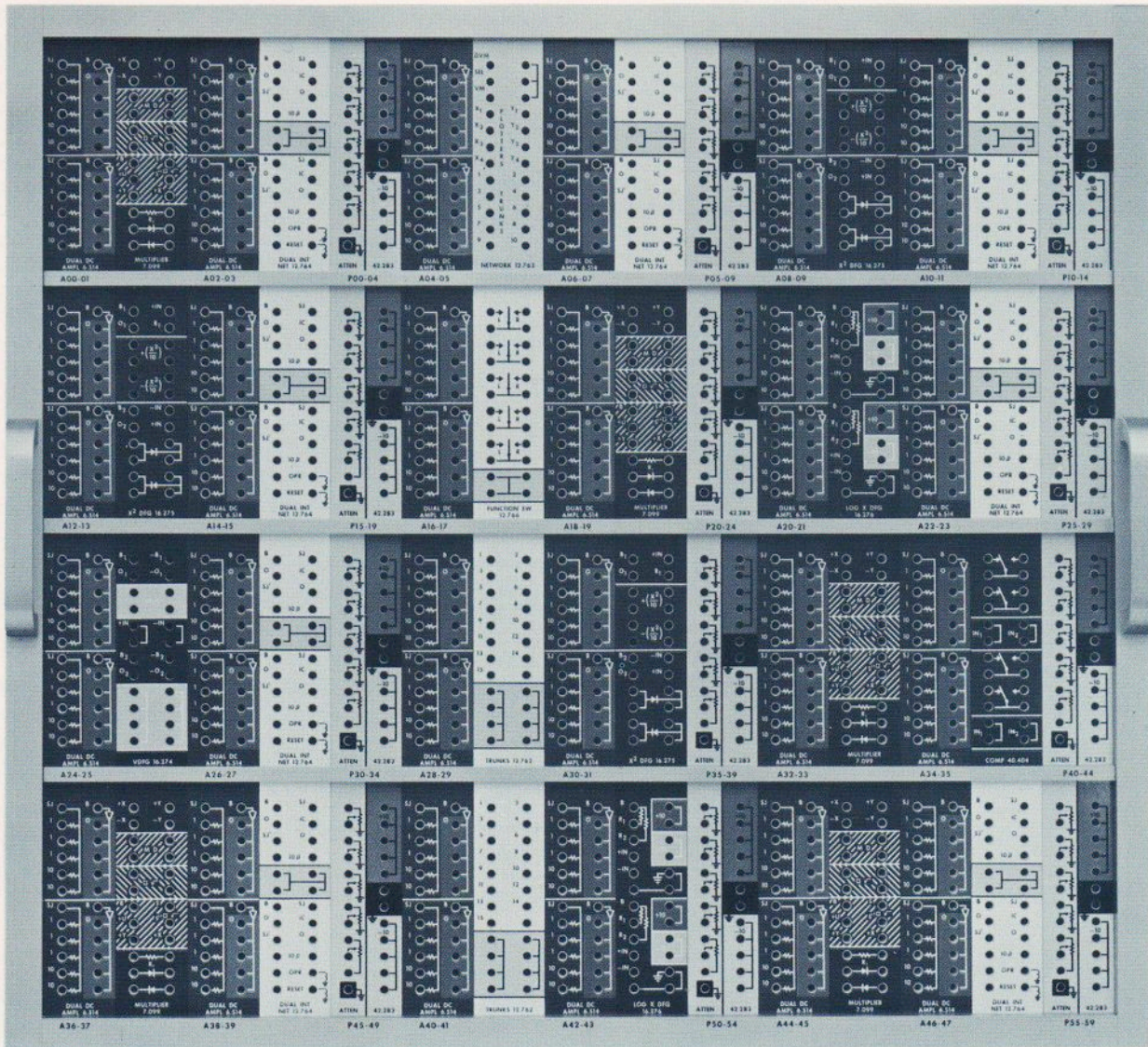

The removable patch panel is arranged as a series of 12 modules, with each module terminating a grouping of linear and non-linear computing components. This design coupled with logical component terminations assures maximum use of bottle plugs, thereby reducing patch panel clutter to a minimum even for large problems. Long, across-the-board patching is cut to a minimum. Problem patching, checking and trouble shooting are more easily accomplished and there is less chance of patching error.

The panel is made up of individual 5 inch high by 1½ inch wide component patching blocks. It is 15 components in width and 4 in height. Patching block terminations correspond to those of the patch bay,

which is formed by the insertion of the plug-in components into the computer. Gold-plated, phosphor-bronze contact springs are inserted into the terminations on the component module so that when the pre-patch panel is placed into the patch bay, positive wiper contact is made with the patch cords and bottle plugs inserted in the patch panel. Unique patch panel design eliminates the possibility of "open" connections due to loose or partial insertion of patch cords. Another important feature of the TR-48 pre-patch panel is the ability to change the layout as the component configuration is changed. This is accomplished by loosening the retaining frame and replacing component patching blocks, or rearranging existing ones as required by the new component configuration.

TR-48

*interchangeable, plug-in components and flexibility
make expansion easy*

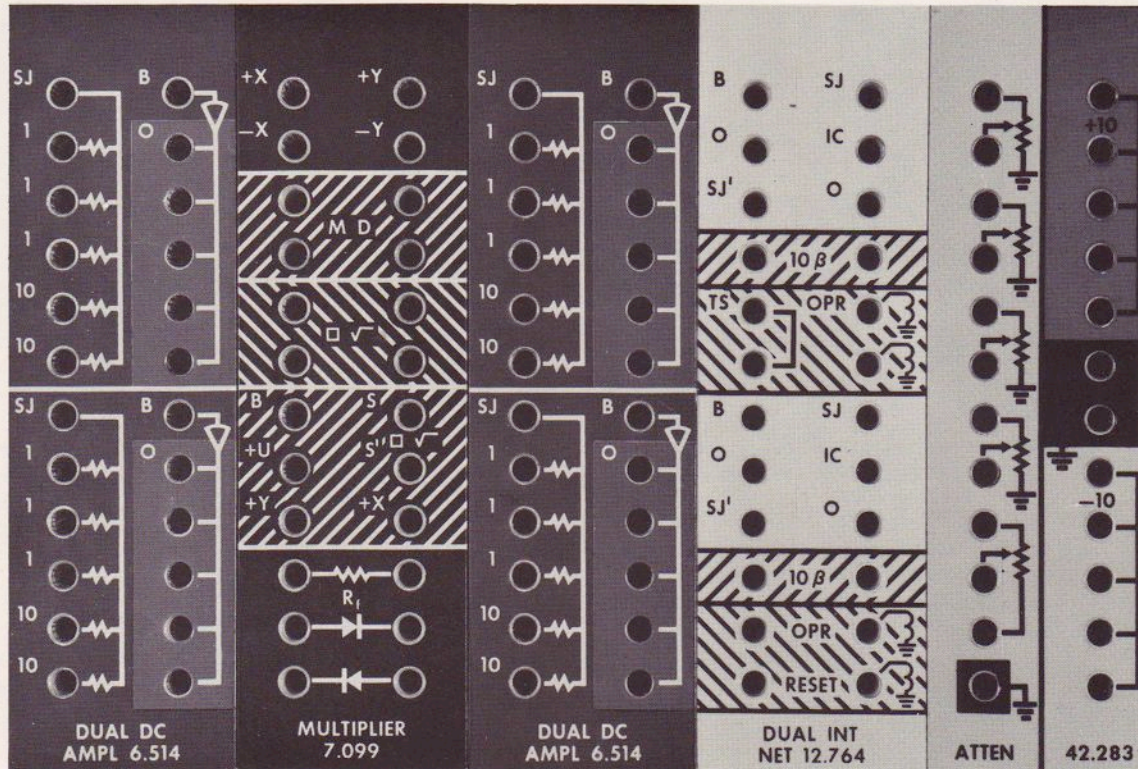

NON-LINEAR

The second position within each modular grouping of components is wired to accept a variety of non-linear computing components. The standard TR-48 is pre-wired to accept the following interchangeable components in this position:

- Type 7.096 or Type 7.099 Multiplier*
- Type 16.274 Variable DFG (5 Selected Positions)*
- Type 16.276 Log X DFG*
- Type 16.281 $\frac{1}{2}$ Log X DFG*
- Type 16.275 X^2 DFG*
- Type 12.764 Dual Integrator Network*

In addition, this position (in the middle column of the modular component groupings) will accept the Type 2.462 Function Switch Group, the Type 12.763 Read-out patching Unit, and the Type 2.426 Trunk Group.

OPERATIONAL AMPLIFIERS

The first and third positions in the module are each wired to accept a plug-in dual operational amplifier unit. These amplifiers are basic to the performance of all mathematical operations available in the TR-48. With companion precision resistor networks terminated on the same patching block, they are used for addition, subtraction, and sign inversion. Integration is performed by patching an operational amplifier to

an appropriate integrator network, located in the fourth position of the module. "High-gain" operational amplifiers are also utilized as output and feedback devices for non-linear components to perform multiplication, division, and function generation. In any case, all amplifiers are "uncommitted"—i.e., can be used in any mode of operation.

INTEGRATOR NETWORKS

This fourth position in the module accepts a Dual Integrator Network, which contains the precision feedback capacitors for use with a high-gain amplifier to perform the operation of integration with respect to time. The position is also wired to accept all non-linear components (including the Type 40.404 comparator), except the Type 16.274 Variable DFG.

COEFFICIENT SETTING POTENTIOMETERS

Position five in the modular grouping of components is wired to accept the Type 2.440 Coefficient Setting Potentiometer Group. This makes available five 10-turn potentiometers used for inserting equation coefficients or problem parameters, initial and boundary conditions, and problem inputs into the computing circuits. There are four grounded and one ungrounded potentiometers in each group.

TR-48 *becomes even more versatile with addition of high speed repetitive operation group 2.424*

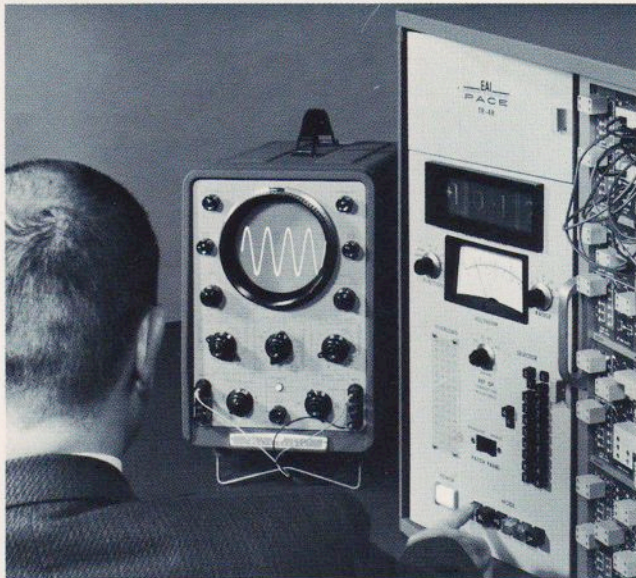

The High Speed Repetitive Operation Group permits the PACE TR-48 to be operated alternately as a real-time or high speed repetitive computing device. The wide bandwidth of the TR-48 solid-state computing components is utilized to produce problem solutions many times each second . . . yet there is no loss in time computing accuracy.

These outstanding features of the Type 2.424 HSRO Group add to the problem solving capabilities of the TR-48 Computer.

- *Instantaneous change from real time or repetitive operation . . . requires no repatching or reprogramming . . . allow immediate, permanent recording of selected solutions.*
- *Computing times of from 20 to 500 milliseconds per solution.*
- *Switched control of solution times at fixed values of 20, 50, 100 and 200 milliseconds per solution.*
- *Continuous control of solution times between the fixed values.*
- *All solid state timing unit.*
- *Precision polystyrene feedback capacitors.*
- *SLAVE feature for control of two or more real time or repetitively operated TR-48 Computers.*

In *repetitive operation*, the computer is continuously cycled between the *reset* and *compute* mode of operation. The problem is, therefore, solved repeatedly at some predetermined repetition rate, usually often enough to allow its presentation on an oscilloscope.

Repetitive operation is obtained by switching the Mode switch on the Control Panel to the Rep. Op. position . . . this automatically changes the feedback capacitors in the *integrator network* so as to increase the time scale by a factor of 500. The Compute Time switch is then used to select the desired repetitive rate of operation. Voltage signals generated by the REP. OP. Timing Unit operate the high speed electro-mechanical relays in each Integrator Network to cycle the computer between the *reset* and *operate* modes. Energizing the *RESET* mode push-button stops the repetitive operation. Since each integrator is capable of individual mode control, parts of the computer may be run in "real time", while other parts operate repetitively. In addition, "multiple-speed" operation may be accomplished, if desired. Thus high-speed "iterative type" solutions may be achieved if required in a given problem.

TYPICAL USES OF HIGH SPEED REP OP

System Optimization . . . the selection of parameter values which give the best overall performance.

Boundary Value Problems . . . the solution of differential equations in which the problem is to find the initial conditions for specified solutions of the equations.

Model Building . . . the problem of determining a mathematical representation for a system of known response.

Other uses of High Speed Repetitive Operation . . . rapid exploratory studies to conserve computing time . . . rapid approximation of optimum system parameters and determination of stability regions of control systems . . . approximate computation and display of integral transforms, such as Fourier integrals, superposition integrals, and correlation functions . . . statistical studies requiring many solutions . . . plus a wide variety of routine computational problems requiring numerous solutions.

TYPICAL PROBLEM AREAS ARE:

Users of the PACE TR-48 Analog Computer will find the High Speed Repetitive Operation Group a valuable aid in the solution of a variety of computing problems. The high problem solution rates make it possible to instantaneously view the effect of varying the parameters of a problem. This unique ability provides a powerful and economical computational tool for solving those problems requiring multiple solutions of the problem equations.

transistorized dc operational amplifier . . . the basic building block of the TR-48

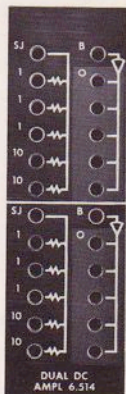
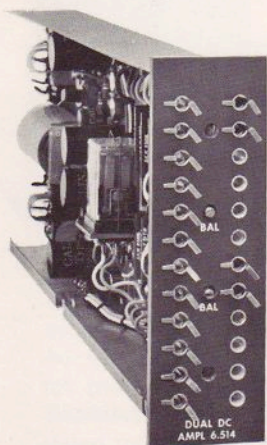

DUAL AMPLIFIER MODULE (Type 6.514)

The heart of the TR-48 is the transistorized DC operational amplifier. By connecting various input or feedback networks to the operational amplifier specific mathematical operations are obtained.

The TR-48 Computer employs identical, interchangeable, amplifier modules each consisting of two transistorized DC amplifiers, terminated on the patch panel as high-gain amplifiers. Companion networks, consisting of input and feedback resistors matched to 0.01% accuracy, are conveniently terminated in the module for converting each amplifier to inverter or summer operation by convenient bottle plugs.

Superior performance characteristics . . . low temperature drift . . . low offset . . . low noise . . . extended usable frequency response.

Completely transistorized . . . for increased reliability . . . backed by the enviable performance record of thousands of similar units operating in the field.

Chopper stabilized . . . each computing amplifier is individually and automatically stabilized to reduce offset and drift to a minimum.

Individual balance adjustment . . . provided on every operational amplifier.

Single-ended input and output . . . emitter-follower bridge output circuit assures linear operation with low output impedance . . . low-current emitter-follower input stage insures high input impedance for excellent drift characteristics.

NOTE:—TR-48 Computing Components, consisting of a computing module and a mated patching module segment of the pre-patch panel, are illustrated above and on the following pages, 8 through 11.

Operational amplifiers in the TR-48 are terminated with companion precision input and feedback resistors. Insertion of a 4-prong bottleplug into the top four holes of the amplifier patching block connects a feedback resistor across the amplifier and the common connection of the input resistors (Summing Junction) to the amplifier base. The amplifier thus functions as a summer with two gain-of-1 and two gain-of-10 inputs. Additional inputs may be connected to the summing junction termination available on the back of the bottle plug. Omission of the 4-prong bottle plug makes the amplifier available as a high gain amplifier for connection to integrator networks or non-linear components.

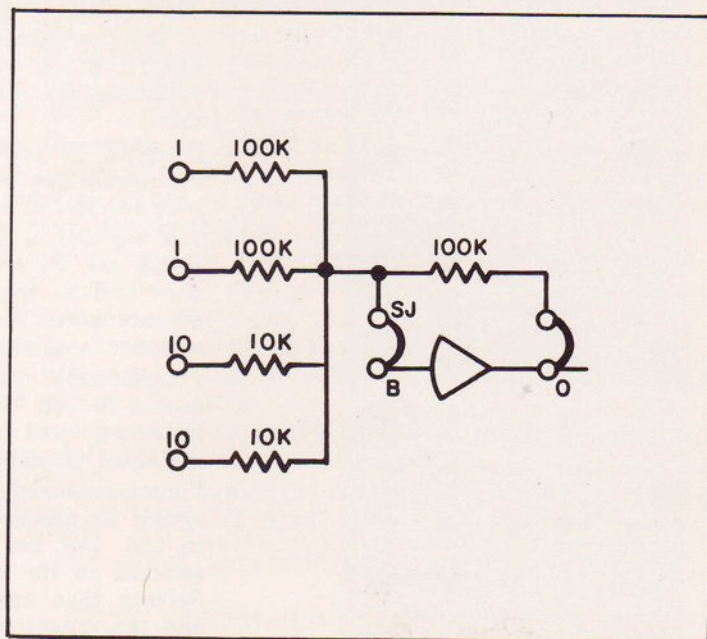

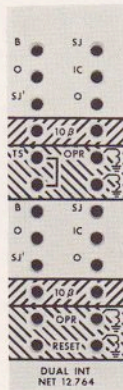
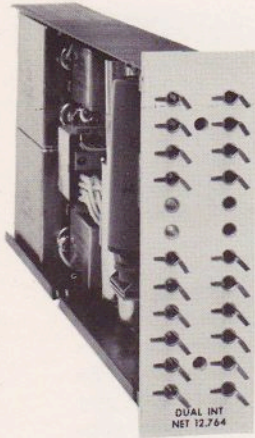

DUAL INTEGRATOR NETWORK (Type 12.764)

- Consists of two networks, each containing the precision capacitors that enable any high gain amplifier to be connected to perform the mathematical operation of integration with respect to time.
- Simple bottle plug patching connects integrator network to adjacent high gain amplifier, thus converting it to an integrator.
- Contains all relays necessary for switching the integrator to RESET, HOLD, OPERATE modes of operation. Relay operation is controlled by computer mode push-button on control panel.
- Makes available "IC" termination for introducing non-zero initial condition directly into the integrator, if required. The same IC termination is used both for the "real time" and the "Rep Op" modes, thus eliminating need for repatching when operating alternately between these modes. In that no additional amplifiers need be used for IC inputs when in Rep Op, redundant equipment usage is eliminated.
- Individual integrator 10 to 1 time scale change accomplished by bottle plug patching in either real time or HSRO operation.
- Precision $\pm 0.05\%$ Polystyrene capacitors used throughout to reduce drift and assure high dynamic accuracy.
- Patching terminations allow separate control of mode of operation of integrators for signal tracking and storage. Multi-speed and iterative operation is thus made feasible.

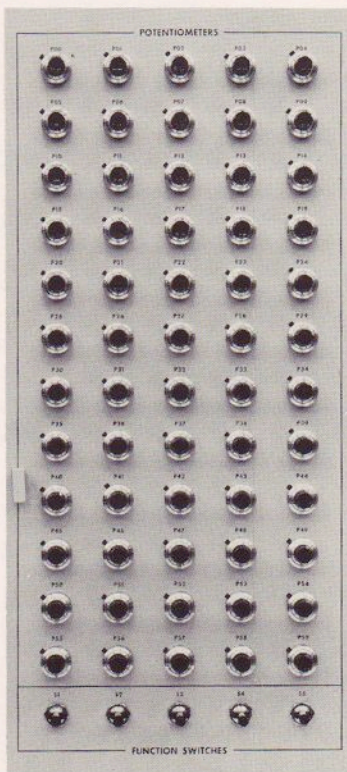

COEFFICIENT SETTING POTENTIOMETER GROUP (Type 2.440)

- Used for setting problem coefficients, initial and boundary conditions, as well as problem inputs.
- Each group provides five potentiometers mounted in the potentiometer area on the right-front of the TR-48, as well as suitable patch panel terminations for their connection into problem circuits.
- Consists of ten-turn, wire-wound, 5,000 ohm potentiometers individually fused and equipped with calibrated adjustment knobs.
- The top and arm of four potentiometers in the group are terminated on the patch panel with their bottom ends internally grounded. The fifth potentiometer is terminated with top, bottom, and arm available at the patch panel.
- Potentiometer patching area includes plus and minus 10 volt reference terminations and convenient ground terminations for grounding ungrounded potentiometers.
- Potentiometer setting has been made extremely simple for the operator. The computer is placed in the "Pot Set" mode and the pot to be set selected on the readout panel. The *Coefficient Setting* then appears on the digital voltmeter and the potentiometer is adjusted as desired.

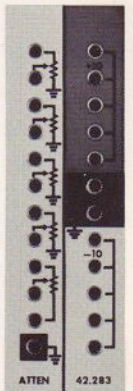
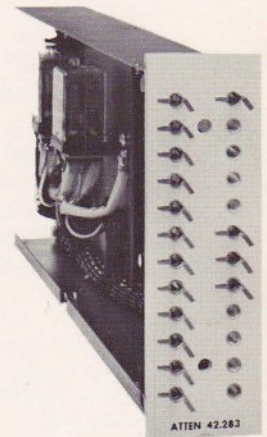

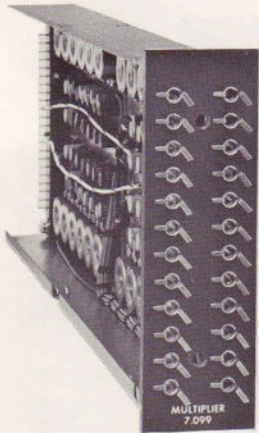

MULTIPLIER (Types 7.099 and 7.096)

A completely solid-state device which makes use of the quarter-square technique of multiplication to produce, when used in conjunction with a high-gain amplifier, a product of two input variables of either polarity. The mathematical operations of division, squaring, and square root may also be performed.

Solid-state reliability . . . silicon diodes and ultra-stable resistors are used throughout to minimize drift and insure long, maintenance-free life.

Wide computing bandwidth . . . dynamic performance unsurpassed by any other type of continuous multiplication device—bandwidth compatible with the wide bandwidth of the amplifier.

Low noise . . . and infinite resolution result from the elimination of servo potentiometers and time division oscillators.

Four Quadrant multiplication . . . when used in association with a transistorized DC amplifier the product— $XY/10$ is produced from inputs $+X$, $-X$, $+Y$ and $-Y$. Output polarity may be easily reversed by interchanging $+X$ and $-X$ or $+Y$ and $-Y$ input connections.

Plug-in design . . . can be plugged into any non-linear or integrator network position—permits rapid replacement for servicing and interchanging of components.

Simplified patching . . . clearly marked patching terminations simplify interconnection between other computing components. Bottle-plug connections place the multiplier in the “multiply”, “divide”, “square” or “square-root” mode of operation.

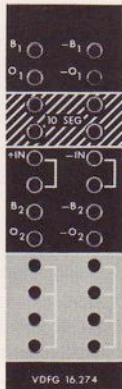
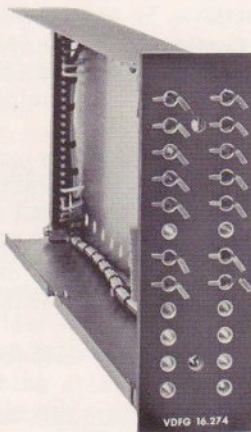

VARIABLE DIODE FUNCTION GENERATOR (Type 16.274)

A fixed breakpoint, variable slope, diode function generator composed of completely solid-state components—used with external high-gain, transistorized operational amplifiers to produce an electrical representation of arbitrary functions by straight line segments.

10/19 Segment Operation . . . VDFG may be used to generate two non-linear functions with a 10-segment representation, one for positive inputs and one for negative inputs, or these may be combined for 19-segment function generation, for input signals of both polarities.

DFG Operation utilizes external high gain transistorized operational amplifiers . . . two required for each 10-segment function generator or for a single 19-segment combination.

Function Set-up to produce a desired function is made by screwdriver adjustment from the side of the DFG chassis. Ten quick adjustments are all that are required for setup.

DFG Chassis is mounted in area over TR-48 Control Panel and is housed in slide-out unit for ease of set-up adjustments.

DFG Patching Module mounts within the computer in a variety of selected non-linear positions of the patch panel.

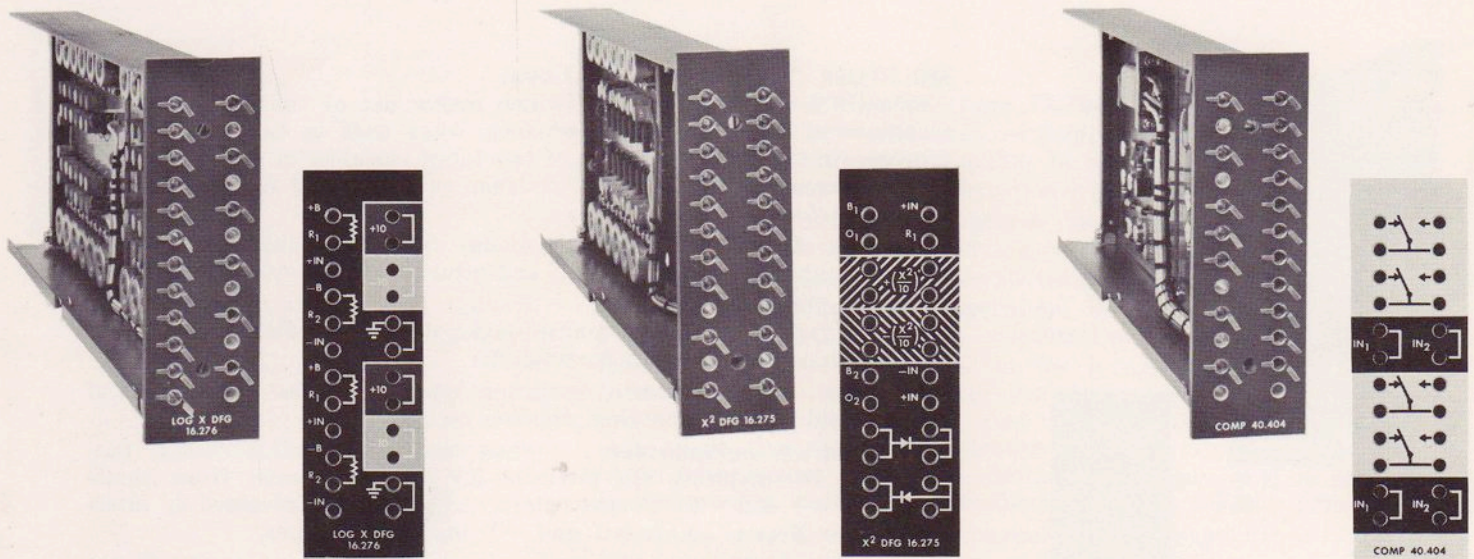

LOG DIODE FUNCTION GENERATOR (Types 16.276 and 16.281)

Log function generators are extremely valuable in a general purpose simulation for raising a variable to an unusual power (i.e., 1.8, 2.6, etc.) or a variable power (i.e., X^x). They are also useful for multiplication, division, squaring, square-rooting, etc. as alternatives for multipliers or other function generators.

The Type 16.276 and 16.281 Log Generators have the following characteristics:

- Dual fixed diode function generators composed of completely solid-state components.
- Two types available:
 1. Type 16.276 produces an output of $5 \text{ Log}_{10}(10X)$ for an X input.
 2. Type 16.281 produces an output of $2.5 \text{ Log}_{10}(10X)$ for an X input.
- When operated in combination with an external high-gain, transistorized operational amplifier, each type of LOG DFG is capable of the following operation:
 - A. Output of Log_{10} for an X input of one polarity.
 - B. Output of $\text{Log}_{10}X_1$ and $\text{Log}_{10}X_2$ when inputs X_1 and X_2 are unipolar and of opposite sign (two amplifiers required).
 - C. An exponent output when the LOG DFG is used in feedback of high-gain amplifier.
- Utilizes six (6) straight line segments to approximate a logarithmic curve for a single sign of input voltage.
- Accepts inputs in the range ± 10 volts DC; provides outputs in the range of ± 10 volts DC depending upon connections.
- Mounts in any non-linear or integrator network position.

DUAL X² DIODE FUNCTION GENERATOR (Type 16.275)

- A dual fixed diode function generator composed completely solid-state components.
- One dual chassis is capable of the following options:
 - A. When operated in combination with an optional amplifier it will yield an X^2 output for an X input of one polarity.
 - B. When operated in combination with two operational amplifiers it will deliver outputs of $(X_1)^2$ and $(X_2)^2$ when both X_1 and X_2 are unipolar and of opposite sign.
 - C. When operating in combination with two operational amplifiers it will deliver an output of X^2 with the input X varying both plus and minus in sign.
 - D. A square root output may be obtained by using the X^2 DFG in the feedback of an operational amplifier.
- Accepts inputs to ± 10 volts, provides outputs of ± 10 volts.
- Fully electronic to provide wide computing bandwidth.

COMPARATOR (Type 40.404)

- Compares a variable input voltage to an arbitrary bias voltage and causes a switching operation to be performed; very useful for "decision making" operations within the computer program.
- Consists of a three-stage, transistor amplifier and a high-speed, double-pole-throw relay.
- When the algebraic sum of input variable and bias voltage is positive, the relay will assume one position and, when this sum is negative, it will assume the other.
- Two comparators mounted in a single plug-in unit . . . can be placed in any non-linear position.

accessories

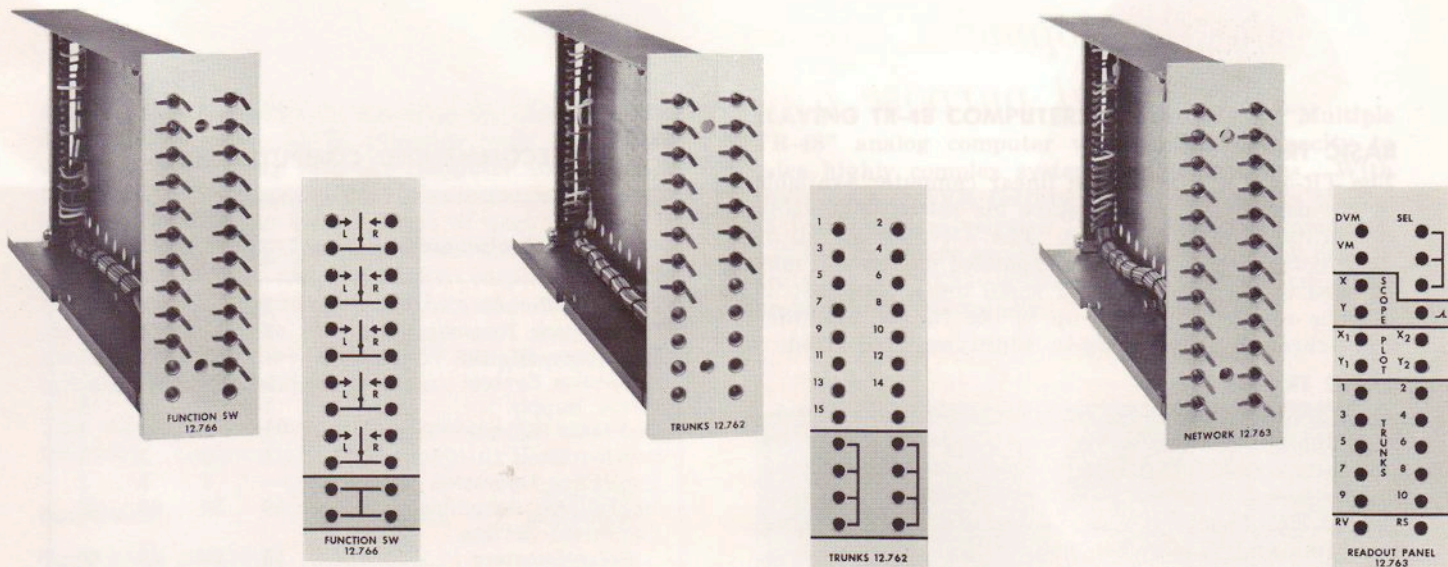

FUNCTION SWITCH GROUP (Type 2.462)

- Provides five independent, single-pole double-throw, center-off, function switches for performing manual switching operations.
- Function switches mounted in lower portion of Coefficient Setting Potentiometer panel.
- Function switch patching area mounts in any one of three lower Integrator Network positions in middle column of component modular groupings.
- Switch contacts are rated at 120 volts, 1.0 amperes resistive load.

TRUNK GROUP (Type 2.426)

- Used for connection of problem signal voltages between two TR-48 Computers operated in parallel, or for connection of computer to external hardware or instrumentation.
- Provides 15 patch panel terminations for rear connected inter-console trunking cables.
- Patching area mounts in integrator network position in any one of three lower rows of the middle column of component modular groupings.

READOUT MODULE (Type 12.763)

- Provides patch panel terminations for accessory recording equipment cabled to rear of TR-48 Computer.
- Terminations provided are:
 - A. X and Y inputs for X-Y Recorder, as well as "automatic pen lift" control of recorder.
 - B. Inputs for two 4-channel time base recorders or one 8-channel recorder, or 10 Trunks, as required.
 - C. X and Y inputs for external oscilloscope.

accessories

- **Bottle Plugs**
 Type 5.173—6-prong "T" for connecting Integrator Network to adjacent high gain amplifier.
 Type 5.172—4-prong for converting high gain amplifier to inverter or summer operation.
 Type 5.174—2-prong-horizontal for connecting adjacent horizontal terminations.
- **Multiple Block (Type 542.605)**
 Provides a 6-hole, off-the-patch-panel tie point for interconnecting patch cords or increasing the number of output holes of computing components.
- **Patching Kit (Type 5.171)** Includes the following:
 - 20 each patch cords Type 510.033-0, 6" long; Color: Black
 - 30 each patch cords Type 510.033-1, 12" long; Color: Brown
 - 20 each patch cords Type 510.033-2, 18" long; Color: Orange
 - 10 each patch cords Type 510.033-4, 30" long, Color: Blue
 - 30 each bottle plugs Type 5.174
 - 32 each bottle plugs Type 5.172
 - 8 each bottle plugs Type 5.173
 - 2 each Multiple Blocks, Type 542.605
- **Service Shelf (Type 51.116)** permits convenient maintenance of computing components under normal operating conditions.

TR-48 can be ordered with the component complement to satisfy individual requirements

BASIC TR-48-0

The TR-48-0 is a minimum linear computer available to the user desiring to acquire his initial computing capability at minimum cost. The TR-48-0 has all of the precision features of the expanded models and may be used in the simulation of small linear systems. It may be readily expanded up to the full 48 amplifier size—through simple plug-in additions, as desired.

BASIC TR-48-1

The TR-48-1 provides for more extended linear simulation than the TR-48-0, but is still designed for the laboratory desiring a reliable and expandable analog computer—at a modest initial investment. The TR-48-1 is capable of solving a variety of linear engineering problems, and as your problems become more complex, your TR-48-1 may be easily expanded.

EXPANDED TR-48-2

The TR-48-2 contains a somewhat larger complement of linear equipment, as well as a variety of non-linear computing elements. Its expanded total capacity makes it ideally suited for the simulation of complex linear and non-linear systems.

EXPANDED TR-48-3

The TR-48-3 represents the computer in its fully expanded form. Highly complex and non-linear simulations may be accomplished on this machine. The complement of equipment within the TR-48-3 is extremely varied and versatile and will satisfy the needs of the typical design engineering activity.

EXPANDED TR-48-3 plus spare non-linear components

- Effectively provides several computers in one console. By purchasing additional interchangeable non-linear components, beyond the maximum capacity, you can achieve unusual computing flexibility.

*Each DFG has one plus voltage card and one minus voltage card.

**Each Log X DFG has two plus cards and two minus cards.

***Each X² DFG contains one plus voltage card and one minus voltage card.

The plus and minus cards in the above DFG's may be used for separate functions or combined.

RECOMMENDED COMPUTER SIZES

Equipment	TR-48			
	-0	-1	-2	-3
Pre-wire Console	1	1	1	1
Push-button Readout System	1	1	1	1
Electronic Digital Voltmeter	—	1	1	1
Reference System	1	1	1	1
Power Supply	1	1	1	1
Overload Indicator Panel	1	1	1	1
Service Shelf	1	1	1	1
Repetitive Operation Group	—	1	1	1
Operational Amplifiers	10	20	32	48
Coefficient Setting				
Potentiometers	10	20	40	60
Integrator Networks	4	8	12	16
Multipliers	—	—	3	5
Variable DFG's*	—	—	4	6
Log X DFG's**	—	—	—	4
X ² DFG's***	—	—	—	2
Comparators	—	—	2	4
Function Switches	—	—	5	5
External Trunks	—	—	15	30
Readout Patching Module	1	1	1	1
Patch Panel	1	1	1	1
Patching Kits	1	1	2	2

OTHER TR-48 EXPANSIONS . . . than those recommended above are readily accomplished by simply plugging in the desired number and type of computing components . . . power voltages, monitoring and control facilities for a fully expanded computer are incorporated in the Basic Computer—no additional wiring necessary.

changing the equipment complement
is easy with the TR-48

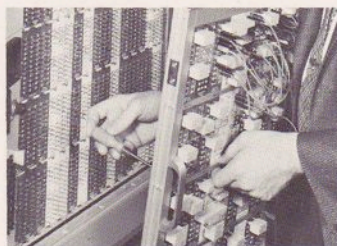

Loosen the pre-patch panel retaining frame.

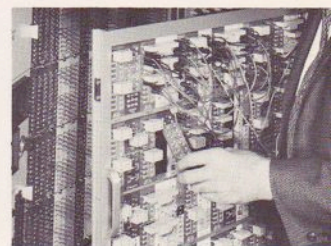

Snap out the patching block of the component to be replaced and replace it with block for the desired component.

TR-48 *versatility allows one computer to do the work of several*

Considerable flexibility in selecting the complement of computing components is available with the TR-48. All components plug into the computer console from the front . . . the patch bay is automatically formed by the terminations on the front of each component. This feature, coupled with the ease of changing the patch panel layout and the ability to place different types of computing components into the same console position, provides an unusual degree of flexibility in arranging different equipment complements, both initially and for later expansion.

The standard TR-48 console is wired to accept the following assignment of computing components:

COMPONENT	POSITION No.	POSITION DESCRIPTION
Type 6.514 Amplifier	0 through 11	Amplifier
Type 42.283 Potentiometer	0 through 11	Potentiometer
Type 12.764 Int. Network	0, 2, 3, 4, 5, 6, 7, 8, 9, 10, 11,	Int. Network
Type 7.099 Multiplier	0, 2, 3, 4, 5, 6, 7, 8, 9, 10, 11,	Non-Linear Int. Network
Type 16.274 VDFG	0 through 11	Non-Linear
Type 16.276 & 16.281 LOG DFG	0 through 11 (with exception of #1 Int. Net.)	Non-Linear Int. Network
Type 16.275 X ² DFG	0 through 11 (with exception of #1 Int. Net.)	Non-Linear Integrator Network
Type 12.763 Recorder	1	Integrator Network
Type 12.766 Function Switch	4, 7, 10	Integrator Network
Type 19.261 Trunks	4, 7, 10	Integrator Network

Note: Special computers may be supplied with different assignment of computing components.

SLAVING TR-48 COMPUTERS . . . provides a "Multiple TR-48" analog computer with sufficient capacity to solve highly complex system design problems. With the TR-48 SLAVE feature you have complete control of your problem solution . . . from either computer. TR-48 Computers are easily SLAVED . . . or disconnected to permit the solution of two or more individual problems simultaneously.

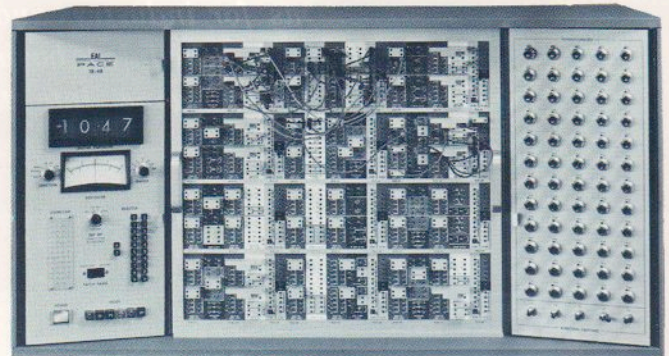

PHYSICAL DESCRIPTION

Width	48 inches
Height	25 inches
Depth	20 1/4 inches
Weight	320 lbs., approx. (fully expanded)
Power Source	115/230 volts, 50-60 cycle
Power Requirement	under 150 watts (fully expanded)

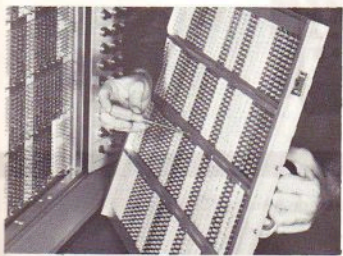

Tighten the pre-patch panel retaining frame.

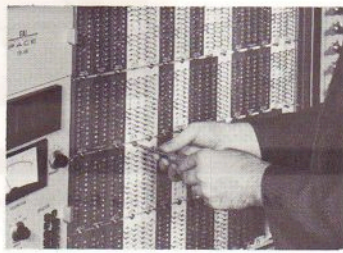

At the front of the computer and with the pre-patch panel removed loosen the two retaining fasteners which secure the component to be replaced.

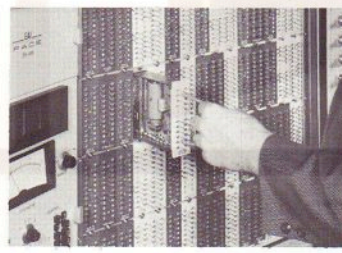

Pull the component out of the computer.

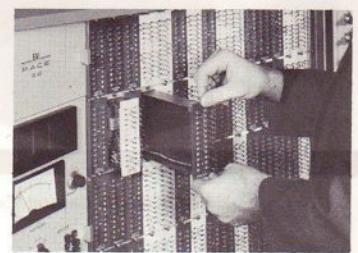

Plug the desired component into the empty position. No re-wiring is necessary.

PACE

TR-48

is backed by EAI's unparalleled experience in the development, manufacture and application of general purpose analog computers

Electronic Associates has designed and built more general purpose analog computers than any other company in the world. In addition it operates four computation centers where EAI analog equipment is in constant use solving problems for industry and formal training in analog computation is provided on a scheduled basis. It is this unmatched experience and know-how that has gone into the development of the PACE TR-48.

PACE 231R — Analog Computer... the standard "100" Amplifier Computer of the industry

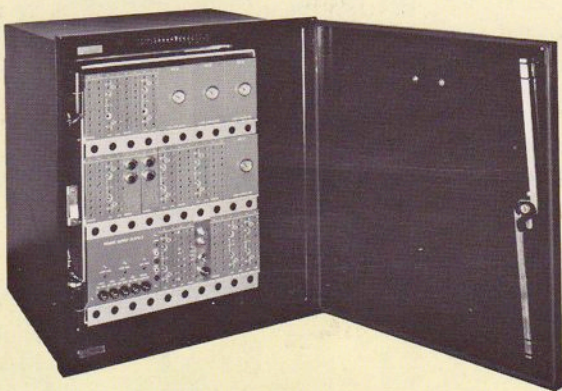
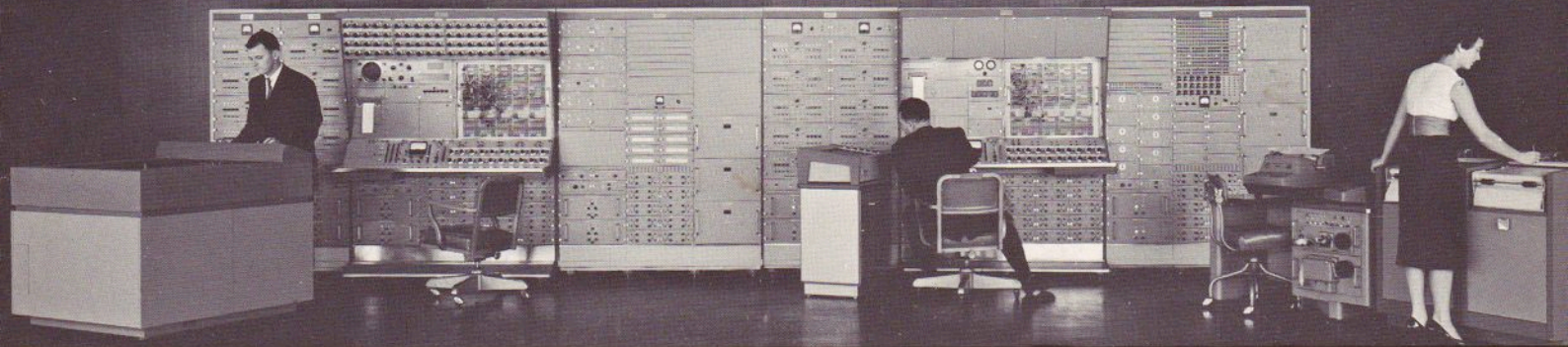

PACE PC-12 Control Computer

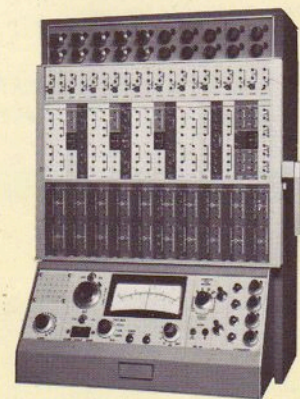

PACE TR-10... the first all-transistorized Analog Computer

(Equipment specifications contained herein are subject to change)